

Varenummer: 2031100M24200B4V

Beskrivelse: E+G Justerfod  
GN 31-100-M24-200-B4-V

Note: V Uden møtrik, udvendig sekskant i toppen, spændeflade i bunden

## Mål

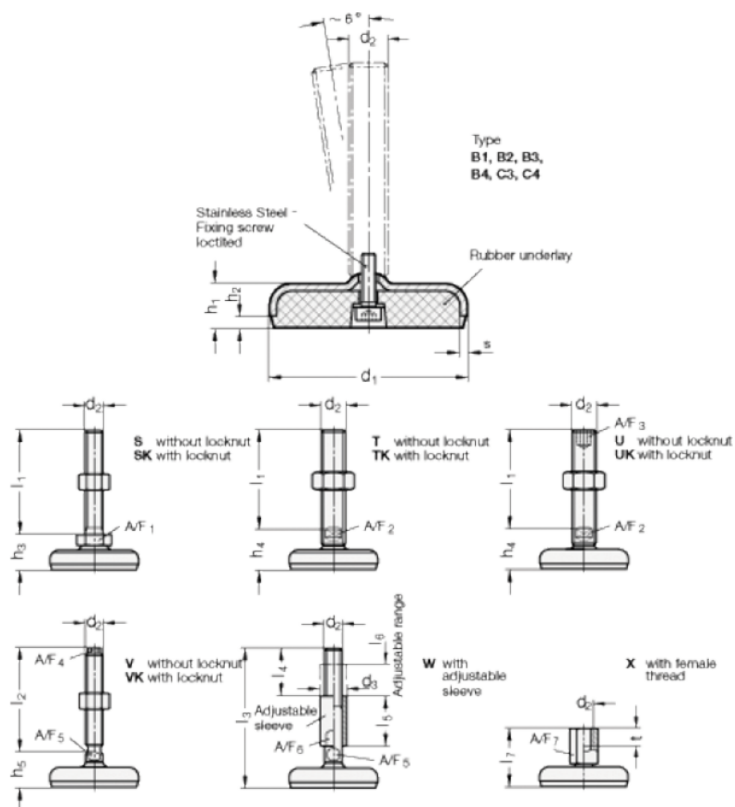

A/F4	= 17	s = 3
A/F5	= 20	
d1	= 100	
d2	= 24	
h1	= 20	
h2	= 6	
h5 +4.0/0	= 35	
l2	= 200	